



# Technical Data Sheet

## 1206 Package Chip Infrared LED

### IR15-21C/L10

#### Features

- Small double-end package
- High reliability
- Low forward voltage
- Good spectral matching to Si photodetector



#### Descriptions

IR15-21C/L10 is an infrared emitting diode in miniature top view flat SMD package and it is molded in a water clear plastic. The device is spectrally matched with silicon photodiode and phototransistor.

#### Applications

- PCB mounted infrared sensor
- Infrared emitting for miniature light barrier
- Floppy disk drive
- Optoelectronic switch
- Smoke detector

#### Device Selection Guide

LED Part No.	Chip	Lens Color
	Material	
IR	GaAlAs	Water Clear

Device No: DIR-152-124

**Package Dimensions**

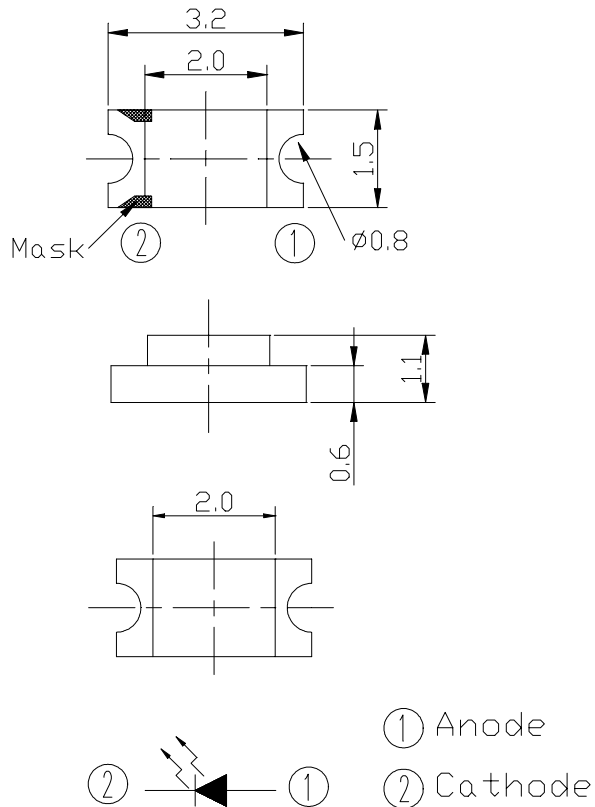

- Notes:** 1.All dimensions are in millimeters  
 2.Tolerances unless dimensions  $\pm 0.1$ mm

**Absolute Maximum Ratings (Ta=25°C)**

Parameter	Symbol	Rating	Units
Continuous Forward Current	$I_F$	65	mA
Peak Forward Current	$I_{FP}$	1.0	A
Reverse Voltage	$V_R$	5	V
Operating Temperature	$T_{opr}$	-40 ~ +85	°C
Storage Temperature	$T_{stg}$	-40 ~ +85	°C
Soldering Temperature	$T_{sol}$	260	°C
Power Dissipation at(or below) 25°C Free Air Temperature	$P_d$	130	mW

- Notes:** \*1: $I_{FP}$  Conditions--Pulse Width  $\leq 100 \mu s$  and Duty  $\leq 1\%$ .  
 \*2:Soldering time  $\leq 5$  seconds.

**Electro-Optical Characteristics (Ta=25°C)**

Parameter	Symbol	Condition	Min.	Typ.	Max.	Units
Radiant Intensity	Ee	I <sub>F</sub> =20mA	0.2	0.8	--	mW/sr
Peak Wavelength	$\lambda_p$	I <sub>F</sub> =20mA	--	940	--	nm
Spectral Bandwidth	$\Delta \lambda$	I <sub>F</sub> =20mA	--	45	--	nm
Forward Voltage	V <sub>F</sub>	I <sub>F</sub> =20mA	--	1.2	1.5	V
Reverse Current	I <sub>R</sub>	V <sub>R</sub> =5V	--	--	10	$\mu$ A
View Angle	2 $\theta$ 1/2	I <sub>F</sub> =20mA	--	160	--	deg

**Intensity Specifications for Bin Grading**

Rank	Test Condition	Min	Max	Unit
E	I <sub>F</sub> =20mA	0.2	1.0	mW/sr
F		0.5	1.5	
G		1.0	2.5	
H		2.0	3.5	

**Typical Electro-Optical Characteristics Curves**

Fig.1 Forward Current vs. Ambient Temperature

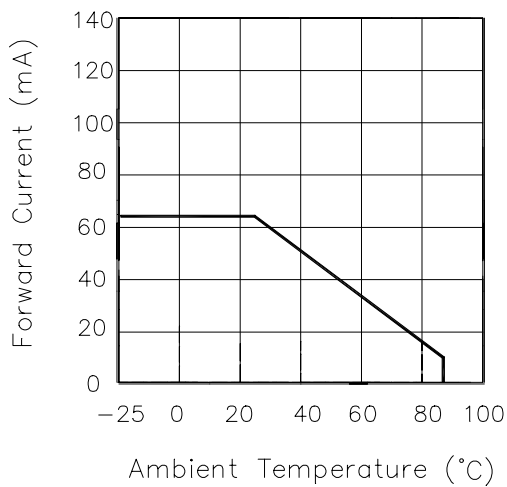

Fig.2 Spectral Distribution

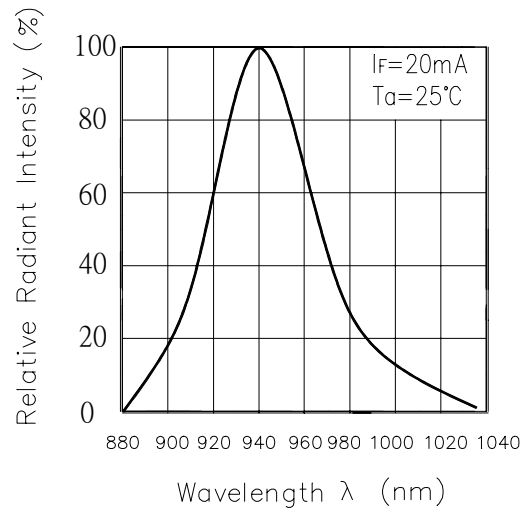

Fig.3 Peak Emission Wavelength λ<sub>p</sub> (nm) vs. Ambient Temperature

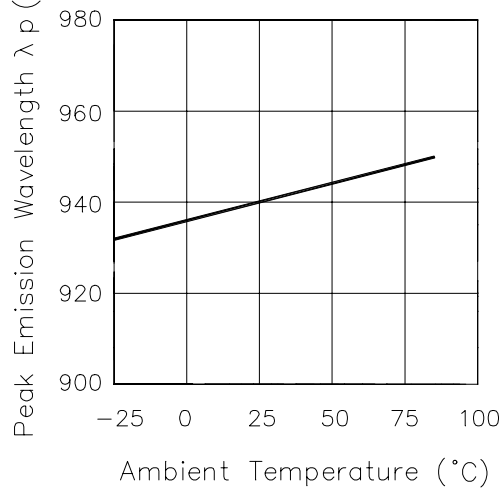
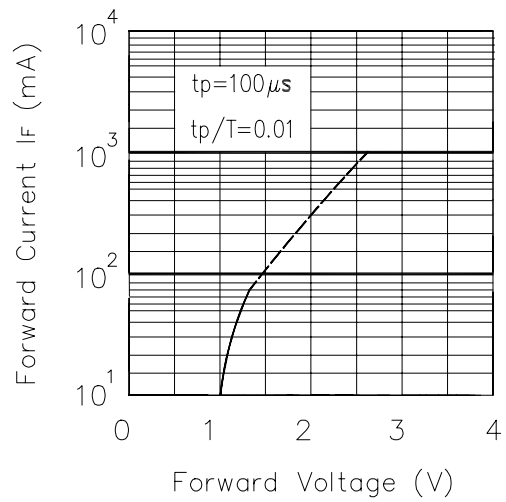

Fig.4 Forward Current vs. Forward Voltage



**Device No:DIR-152-124**

**Typical Electro-Optical Characteristics Curves**

Fig.5 Relative Intensity vs. Forward Current

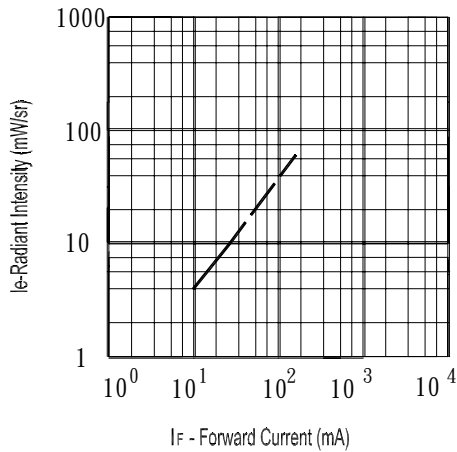

Fig.7 Relative Intensity vs. Ambient Temperature (° C)

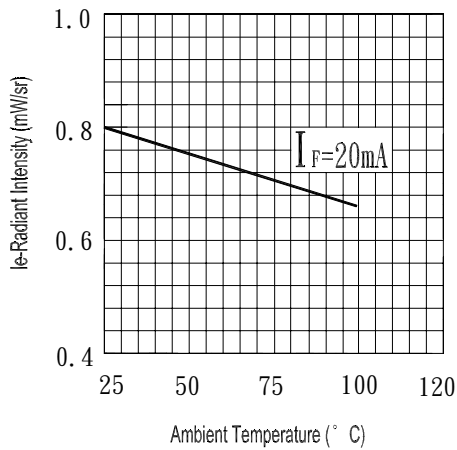

Fig.6 Relative Radiant Intensity vs. Angular Displacement

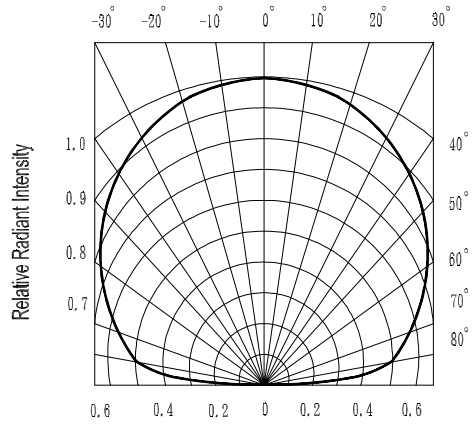
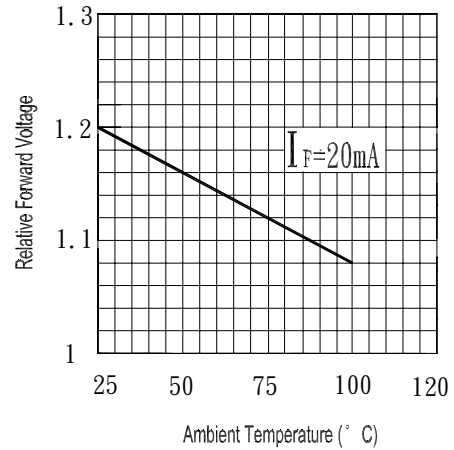
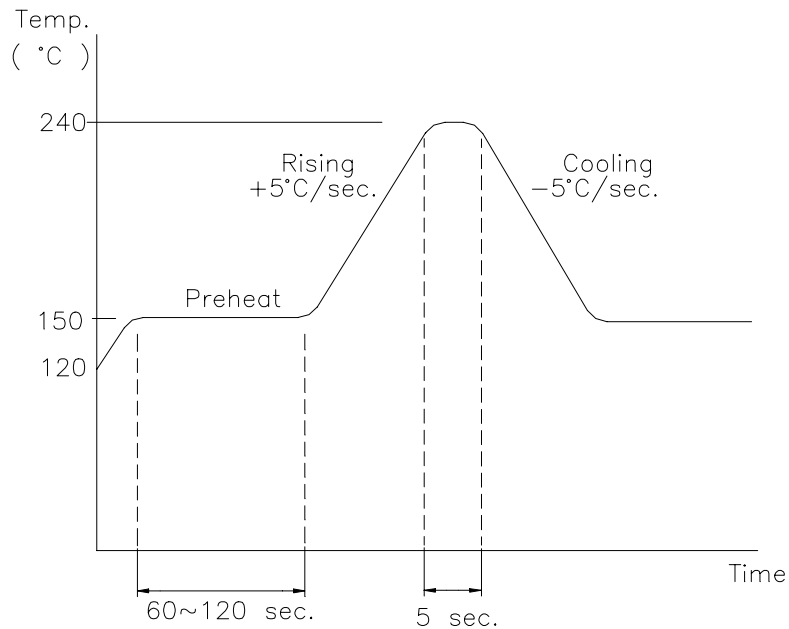

Fig.8 Forward Current vs. Ambient Temperature (° C)



**Device No:DIR-152-124**



**Reflow Temp./Time****Precautions For Use****1.Over-current-proof**

Customer must apply resistors for protection , otherwise slight voltage shift will cause big current change(Burn out will happen).

**2.Storage**

2.1 The operation of temperature and R.H are : 5°C~35°C , R.H.60%.

2.2 Once the package is opened , the products be should be used within a week.

Otherwise , they should be keep in a damp proof box with desiccating anent.

Considering the tape life , we suggest our customers to use our products within a year (from production date).

2.3 If opened more than one week in an atmosphere 5°C~35°C , R.H.60%. , they should be treated at 60°C± 5°C for 15hrs.

2.4 When you discover that the desiccant in the package has a pink color(normal=blue), you should treat them in the same conditions as2.3

**Device No:DIR-152-124**



**IR15-21C/L10**

**Reliability Test Item And Condition**

The reliability of products shall be satisfied with items listed below.

Confidence level : 90%

LTPD : 10%

NO.	Item	Test Conditions	Test Hours/ Cycles	Sample Sizes	Failure Judgement Criteria	Ac/Re
1	REFLOW	TEMP. : 240°C ± 5°C 5secs	6mins	22pcs	More than 90% of lead to be covered by soldering	0/1
2	Temperature Cycle	H : +85°C    30mins ↕ 5mins ↕ L : -55°C    30mins	50Cycle	22pcs	$I_R \geq U \times 2$ $E_e \leq L \times 0.8$	0/1
3	Thermal Shock	H : +100°C    5mins ↕ 10secs ↕ L : -10°C    5mins	50Cycle	22pcs	$V_F \geq U \times 1.2$	0/1
4	High Temperature Storage	TEMP. : +100°C	1000hrs	22pcs	Specification Limit	0/1
5	Low Temperature Storage	TEMP. : -55°C	1000hrs	22pcs	L : Lower Specification	0/1
6	DC Operating Life	$I_F = 20mA$	1000hrs	22pcs	Limit	0/1
7	High Temperature/ High Humidity	85°C / 85% R.H	1000hrs	22pcs		0/1

**EVERLIGHT ELECTRONICS CO., LTD.**  
Office: No 25, Lane 76, Sec 3, Chung Yang Rd,  
Tucheng, Taipei 236, Taiwan, R.O.C

Tel: 886-2-2267-2000, 2267-9936  
Fax: 886-2267-6244, 2267-6189, 2267-6306  
<http://www.everlight.com>

**Device No:DIR-152-124**