



DEVICE NUMBER : DTD-152-001 REV : 1.0
ECN : _____ PAGE : 1/7

1206 Package Silicon PIN Photodiode

MODEL NO : PD15-22B/TR8

■ Features :

- Fast response time
- High photo sensitivity
- Small junction capacitance
- Package in 8mm tape on 7" diameter reel.

■ Description :

- PD15-22B/TR8 is a high speed and high sensitive PIN photodiode in miniature flat top view lens SMD package and it is molded in a black transparent plastic. The device is spectrally matched with the infrared emitting diode.

■ Applications :

- High speed photo detector
- Copier
- Optoelectronic switch
- Game machine

PART NO.	CHIP	LENS COLOR
	MATERIAL	
PD	Silicon	Black

1206 Package Silicon PIN Photodiode

MODEL NO : PD15-22B/TR8

■ Package Dimensions :

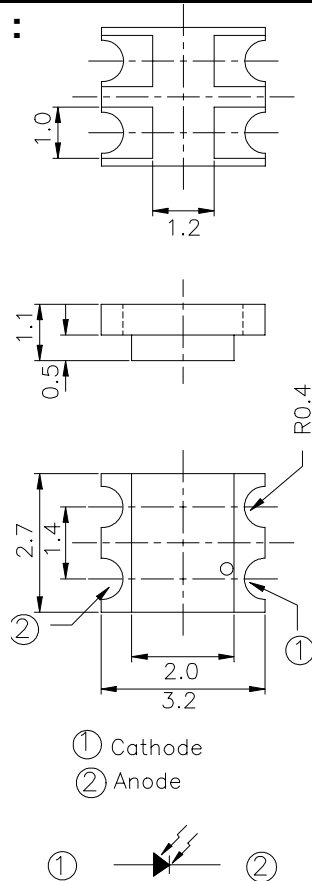

■ Notes :

- 1.All dimensions are in millimeter.
- 2.General Tolerance: $\pm 0.1\text{mm}$
- 3.Lens color : Black transparent.
- 4.Above specification may be changed without notice. EVERLIGHT will reserve authority on material change for above specification.
- 5.These specification sheets include materials protected under copyright of EVERLIGHT corporation . Please don't reproduce or cause anyone to reproduce them without EVERLIGHT's consent.
- 6.When using this product , please observe the absolute maximum ratings and the instructions for use outlined in these specification sheets. EVERLIGHT assumes no responsibility for any damage resulting from use of the product which does not comply with the absolute maximum ratings and the instructions included in these specification sheets.



DEVICE NUMBER : DTD-152-001 REV : 1.0
ECN : _____ PAGE : 3/7

1206 Package Silicon PIN Photodiode

MODEL NO : PD15-22B/TR8

■ Absolute Maximum Ratings at T_A = 25°C

Parameter	Symbol	Rating	Unit	Notice
Reversr Voltage	V _R	32	V	
Operating Temperature	Topr	-25 ~ +85	°C	
Storage Temperature	Tstg	-40 ~ +85	°C	
Lead Soldering Temperature	Tsol	260	°C	
Power Dissipation at(or below) 25°C Free Air Temperature	P _C	150	mW	

■ Electronic Optical Characteristics :

Parameter	Symbol	Min.	Typ.	Max.	Unit	Condition
Rang of Spectral Bandwidth	$\lambda_{0.5}$	----	730-1200	----	nm	----
Wavelength of Peak Sensitivity	λ_p	----	980	----	nm	----
Open-Circuit Voltage	V _{OC}	----	0.41	----	V	E _e =5mW/cm ² λ_p =940nm
Short-Circuit Current	I _{SC}	----	15	----	μ A	
Reverse Light Current	I _L	----	15	----	μ A	E _e =5mW/cm ² λ_p =940nm V _R =5V
Dark Current	I _D	----	----	10	nA	E _e =0mW/cm ² V _R =10V
Reverse Breakdown Voltage	B _{VR}	32	170	----	V	E _e =0mW/cm ² I _R =100 μ A
Total Capacitance	C _t	----	6	----	pF	E _e =0mW/cm ² f=1MHZ V _R =5V
Turn-on/Turn-off Time	t _{on} /t _{off}	----	10/10	----	nS	R _L =1000 Ω V _R =10V

1206 Package Silicon PIN Photodiode

MODEL NO : PD15-22B/TR8

■ Typical Electrical/Optical/Characteristics Curves :

Fig. 1 Power Dissipation vs. Ambient Temperature

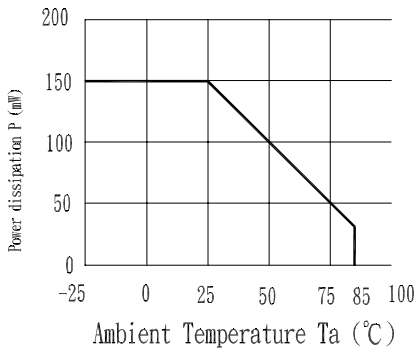

Fig. 2 Spectral Sensitivity

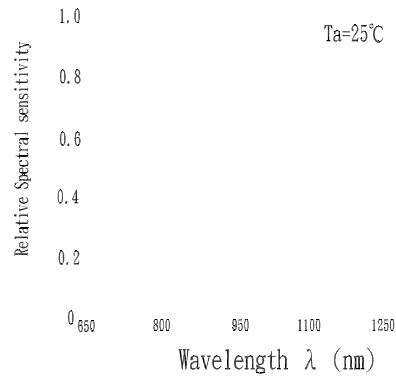

Fig. 3 Dark Current vs. Ambient Temperature

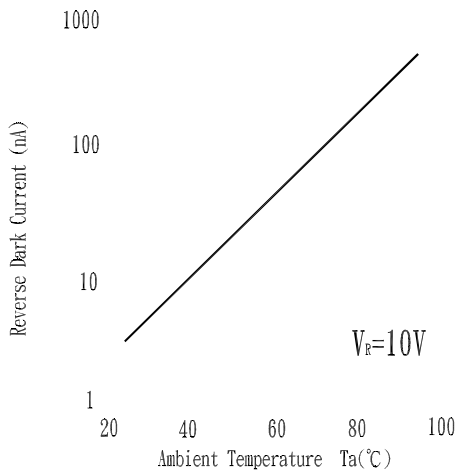

Fig. 4 Reverse Light Current vs. Ee

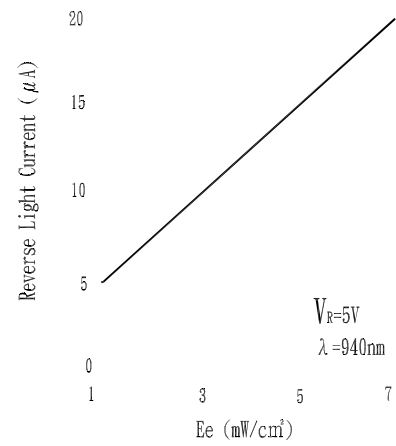

Fig. 5 Terminal Capacitance vs. Reverse Voltage

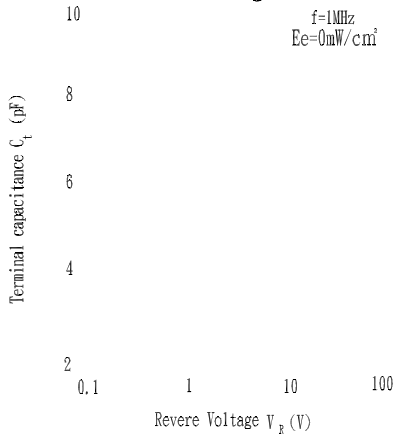
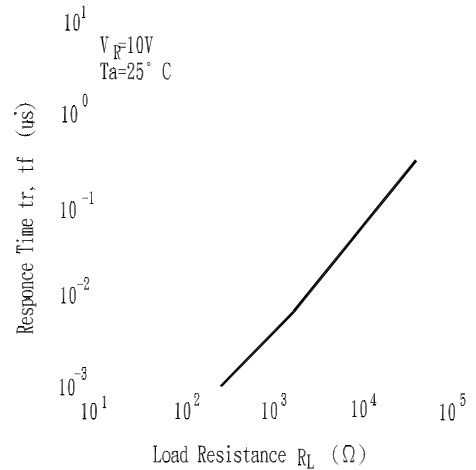

Fig. 6 Responce Time vs. Load Resistance





1206 Package Silicon PIN Photodiode

MODEL NO : PD15-22B/TR8

■ Reliability Test Item And Condition

The reliability of products shall be satisfied with items listed below.

Confidence level:90%

LTPD:10%

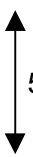
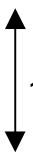
NO.	Item	Test Conditions	Test Hours/ Cycle	Sample Size	Failure Judgement Criteria	Ac/Re
1	REFLOW	TEMP : 240°C ± 5 °C 5 sec	6 Min	22 PCs	$I_L \leq L \times 0.8$ L:Lower specification limit	0/1
2	Temperature Cycle	H : +85°C 30 min  L : -55°C 30 min	50 cycle	22 PCs		0/1
3	Thermal Shock	H : +100°C 5 min  L : -10°C 30 min	50 cycle	22 PCs		0/1
4	High Temperature Storage	TEMP. : +100°C	1000 hrs	22 PCs		0/1
5	Low Temperature Storage	TEMP. : -55°C	1000 hrs	22 PCs		0/1
6	DC Operating Life	$V_R=5V$	1000 hrs	22 PCs		0/1
7	High Temperature / High Humidity	85°C / 85% R.H.	1000 hrs	22 PCs		0/1



DEVICE NUMBER : DTD-152-001 REV : 1.0
ECN : _____ PAGE : 7/7

1206 Package Silicon PIN Photodiode

MODEL NO : PD15-22B/TR8

■ Packing Specifications

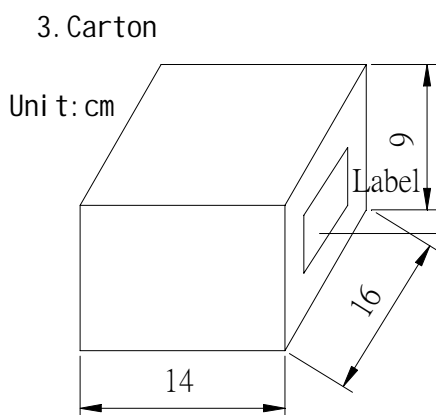
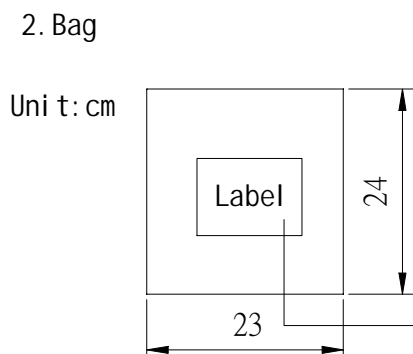
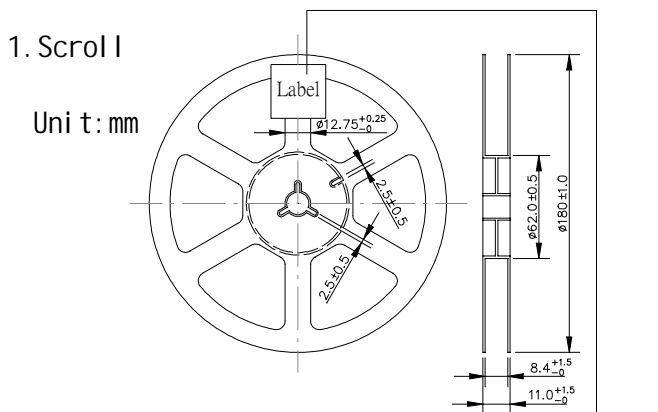

CPN:

P/N:



PD15-22B/TR8

QTY:



LOT NO:

CAT:

HUE:

REF:

MADE IN TAIWAN

CPN : Customer's Production Number

P/N : Production Number

QTY : Packing Quantity

CAT : Ranks

HUE : Peak Wavelength

REF : Reference

LOT NO : Lot Number

MADE IN TAIWAN : Production place

■ Packing Quantity Specification

1.2000 Pcs/1Volume , 1Volume/1Bag

2.10Bags/1Carton