

## Technical Data Sheet

### 5mm Silicon PIN Photodiode , T-1 3/4

#### PD333-3C/H0/L1

#### Features

- Fast response time
- High photo sensitivity
- Small junction capacitance

#### Descriptions

PD333-3C/H0/L1 is a high speed and high sensitive PIN photodiode in a standard 5  $\phi$  plastic package. The device is spectrally matched to infrared emitting diode.



#### Applications

- High speed photo detector
- Security system
- Camera

#### Device Selection Guide

LED Part No.	Chip	Lens Color
	Material	
PD	Silicon	Water clear

Device No:DPD-033-070

**Package Dimensions**

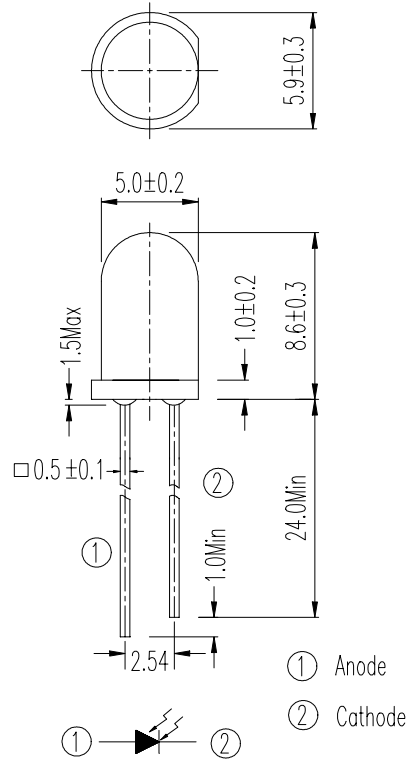

- Notes:** 1.All dimensions are in millimeters  
2.Tolerances unless dimensions  $\pm 0.25\text{mm}$

**Absolute Maximum Ratings (Ta=25°C)**

Parameter	Symbol	Rating	Units
Reverse Voltage	$V_R$	32	V
Power Dissipation	$P_d$	150	mW
Lead Soldering Temperature	$T_{sol}$	260	°C
Operating Temperature	$T_{opr}$	-25 ~ +85	°C
Storage Temperature	$T_{stg}$	-40 ~ +85	°C

**Notes:** \*1:Soldering time  $\leq 5$  seconds.

**Electro-Optical Characteristics (Ta=25°C)**

Parameter	Symbol	Condition	Min.	Typ.	Max.	Units
Rang of Spectral Bandwidth	$\lambda_{0.5}$	-----	---	400-1100	---	nm
Wavelength of Peak Sensitivity	$\lambda_p$	-----	---	860	---	nm
Open-Circuit Voltage	$V_{OC}$	Ee=5m W/cm <sup>2</sup> $\lambda_p=940\text{nm}$	---	0.41	---	V
Short- Circuit Current	$I_{SC}$	Ee=1m W/cm <sup>2</sup> $\lambda_p=940\text{nm}$	---	20	---	$\mu A$
Reverse Light Current	$I_L$	Ee=1m W/cm <sup>2</sup> $\lambda_p=940\text{nm}$ $V_R=5V$	---	20	---	
Dark Current	$I_d$	Ee=0m W/cm <sup>2</sup> $V_R=10V$	---	---	10	nA
Reverse Breakdown	$BV_R$	Ee=0m W/cm <sup>2</sup> $I_R=100 \mu A$	32	170	---	V
Total Capacitance	$C_t$	Ee=0m W/cm <sup>2</sup> $V_R=5V$ $f=1\text{MHZ}$	---	6	---	pF
Rise/Fall Time	$t_r/t_f$	$V_R=10V$ $R_L=1000 \Omega$	---	10/10	---	nS

**Device No:DPD-033-070**

**Typical Electro-Optical Characteristics Curves**

Fig. 1 Power Dissipation vs. Ambient Temperature

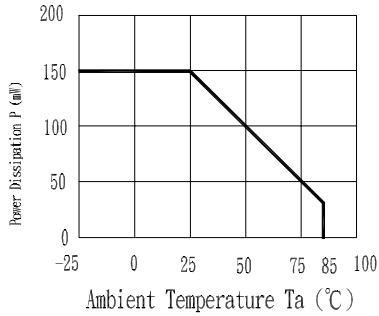

Fig. 2 Spectral Sensitivity

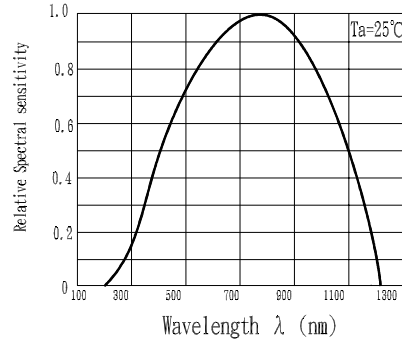

Fig. 3 Dark Current vs. Ambient Temperature

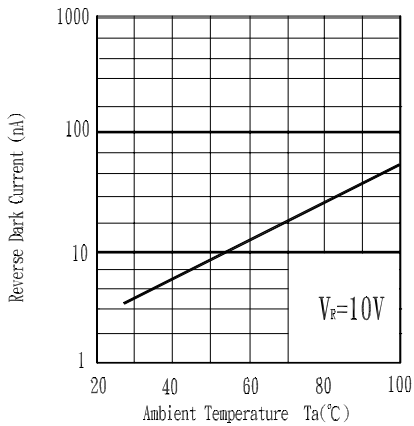

Fig. 4 Reverse Light Current vs.  $E_e$

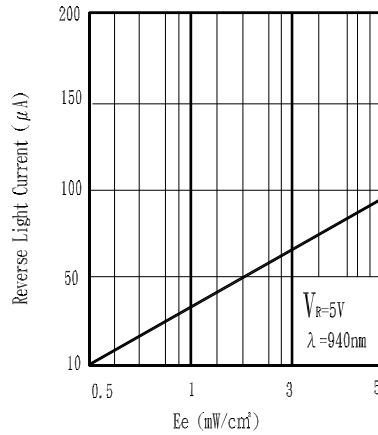

Fig. 5 Terminal Capacitance vs. Reverse Voltage

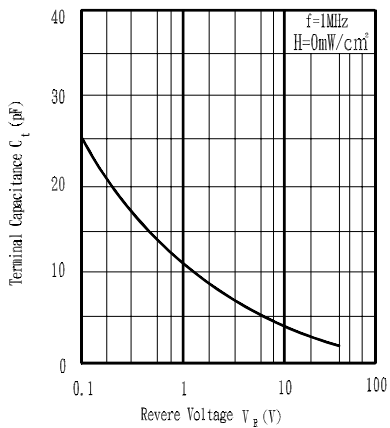
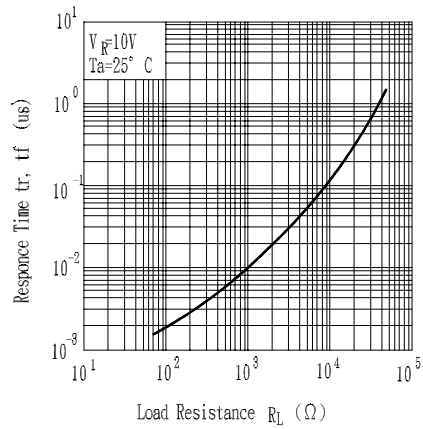

Fig. 6 Response Time vs. Load Resistance



**Device No:DPD-033-070**

**Reliability Test Item And Condition**

The reliability of products shall be satisfied with items listed below.

Confidence level : 90%

LTPD : 10%

NO.	Item	Test Conditions	Test Hours/ Cycles	Sample Sizes	Failure Judgement Criteria	Ac/Re
1	Solder Heat	TEMP :260°C± 5°C	10secs	22pcs	$I_R \geq U \times 2$ $E_e \leq L \times 0.8$ $V_F \geq U \times 1.2$  U : Upper Specification  Limit L : Lower Specification Limit	0/1
2	Temperature Cycle	H : +85°C    30mins ↑ 5mins ↓ L : -55°C    30mins	50Cycles	22pcs		0/1
3	Thermal Shock	H :+100°C    5mins ↑ 10secs ↓ L :-10°C     5mins	50Cycles	22pcs		0/1
4	High Temperature Storage	TEMP. : +100°C	1000hrs	22pcs		0/1
5	Low Temperature Storage	TEMP. : -55°C	1000hrs	22pcs		0/1
6	DC Operating Life	$V_R=5V$	1000hrs	22pcs		0/1
7	High Temperature/ High Humidity	85°C / 85% R.H	1000hrs	22pcs		0/1

<b>EVERLIGHT ELECTRONICS CO., LTD.</b> Office: No 25, Lane 76, Sec 3, Chung Yang Rd, Tucheng, Taipei 236, Taiwan, R.O.C	Tel: 886-2-2267-2000, 2267-9936 Fax: 886-2267-6244, 2267-6189, 2267-6306 http://www.everlight.com
---	---

**Device No:DPD-033-070**