



Technical Data Sheet

Silicon Planar PIN Photodiode

PD70-01B/TR7

Features

- Daylight filter
- High sensitivity
- Low capacitance
- Short switching time
- Wide temperature range
- Small package



Descriptions

- The PD70-01B/TR7 is high sensitivity, fast switching times, low capacitance, compact size, and lack of measurable degradation make it suitable for diverse applications, such as TV and appliance remote control, IR sound transmission, video recorders, and measurement and control.

Applications

- High speed photo detector
- Copier
- Elevator

Device Selection Guide

LED Part No.	Chip	Lens Color
	Material	
PD	Silicon	Black

Package Dimensions

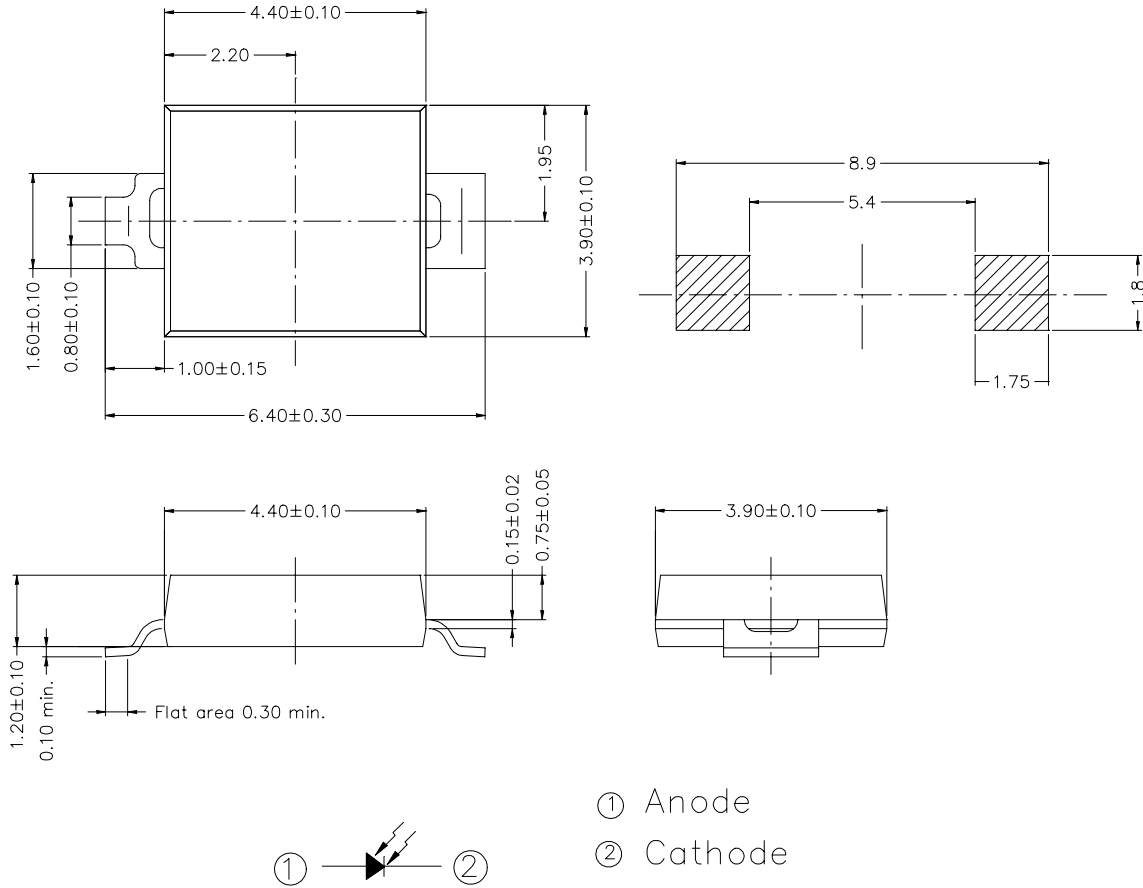

- Notes:** 1.All dimensions are in millimeters
2.Tolerances unless dimensions $\pm 0.1\text{mm}$

Absolute Maximum Ratings (Ta=25°C)

Parameter	Symbol	Rating	Units
Reverse Voltage	V_R	32	V
Operating Temperature	T_{opr}	-25 ~ +85	°C
Storage Temperature	T_{stg}	-40 ~ +85	°C
Soldering Temperature	T_{sol}	260	°C
Power Dissipation at(or below) 25°C Free Air Temperature	P_c	150	mW

Notes: *1:Soldering time ≤ 5 seconds.

Electro-Optical Characteristics (Ta=25°C)

Parameter	Symbol	Condition	Min	Typ	Max	Unit
Rang Of Spectral Bandwidth	$\lambda_{0.5}$	---	730	---	1100	nm
Wavelength Of Peak Sensitivity	λ_p	---	---	940	---	nm
Open-Circuit Voltage	V_{OC}	$E_e=5mW/cm^2$ $\lambda_p=940nm$	---	0.35	---	V
Short- Circuit Current	I_{SC}	$E_e=1mW/cm^2$ $\lambda_p=940nm$	---	35	---	μA
Reverse Light Current	I_L	$E_e=1mW/cm^2$ $\lambda_p=870nm$ $V_R=5V$	17	25	---	μA
		$E_e=1mW/cm^2$ $\lambda_p=940nm$ $V_R=5V$	25	37	---	
Reverse Dark Current	I_D	$E_e=0mW/cm^2$ $V_R=10V$	---	5	30	nA
Reverse Breakdown Voltage	B_{VR}	$E_e=0mW/cm^2$ $I_R=100 \mu A$	32	170	---	V
Total Capacitance	C_t	$E_e=0mW/cm^2$ $V_R=3V$ $f=1MHz$	---	25	---	pF
Rise/Fall Time	t_r/t_f	$V_R=10V$ $R_L=1K \Omega$	---	50/50	---	nS

Typical Electro-Optical Characteristics Curves

Fig.1 Power Dissipation vs. Ambient Temperature

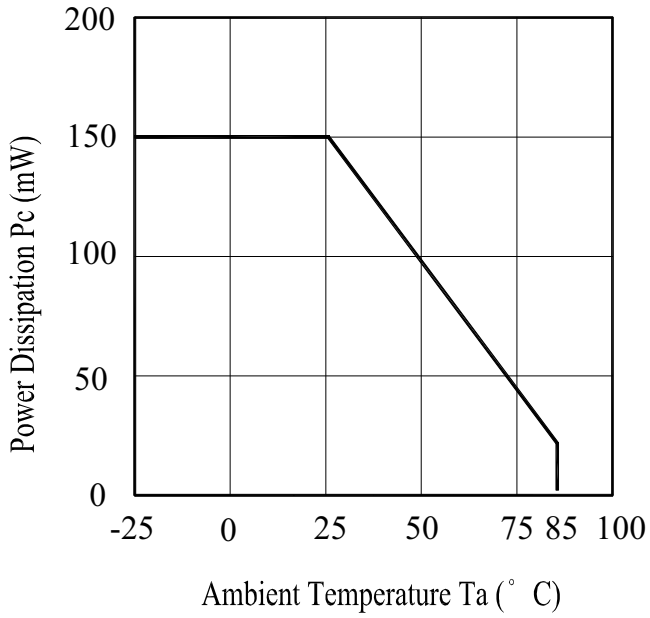

Fig.2 Spectral Sensitivity

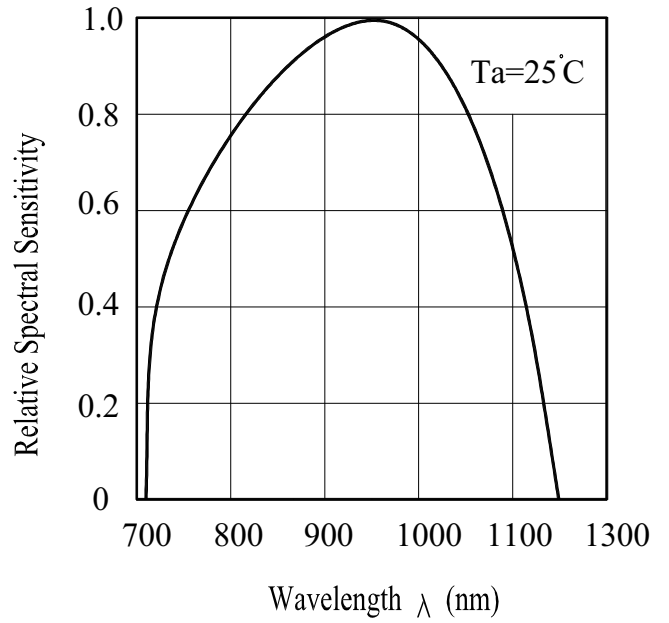

Fig.3 Dark Current vs. Ambient Temperature

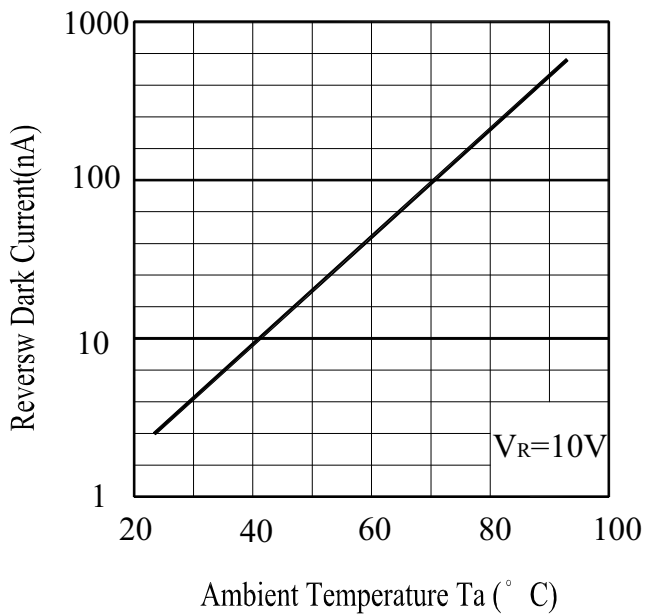
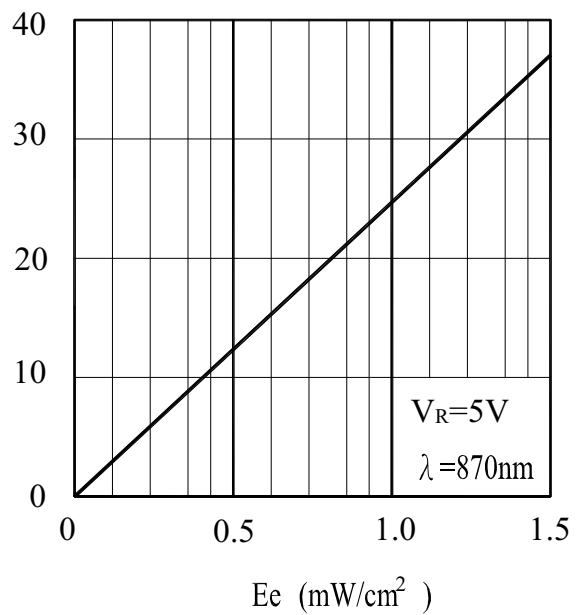

Fig. 4 Reverse Light Current vs. E_e



Typical Electro-Optical Characteristics Curves

Fig.5 Terminal Capacitance vs. Reverse Voltage

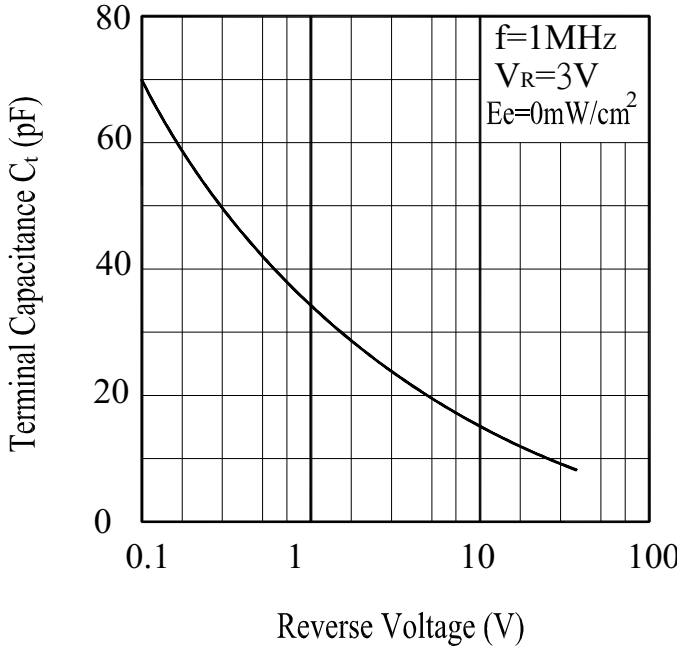
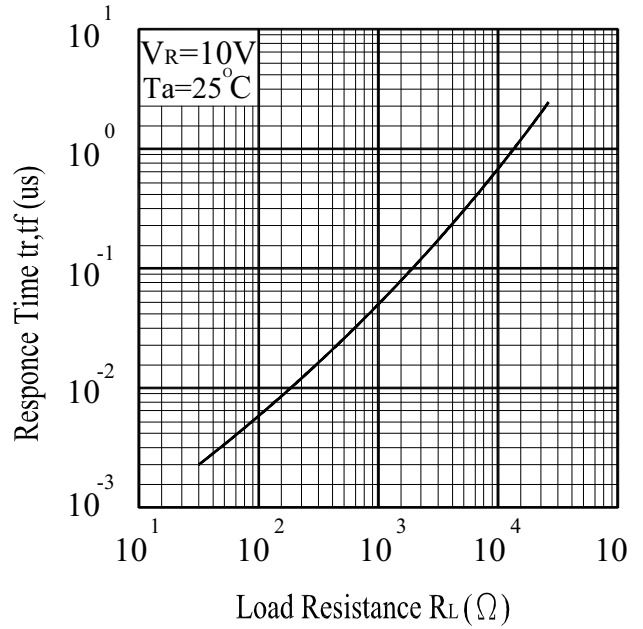
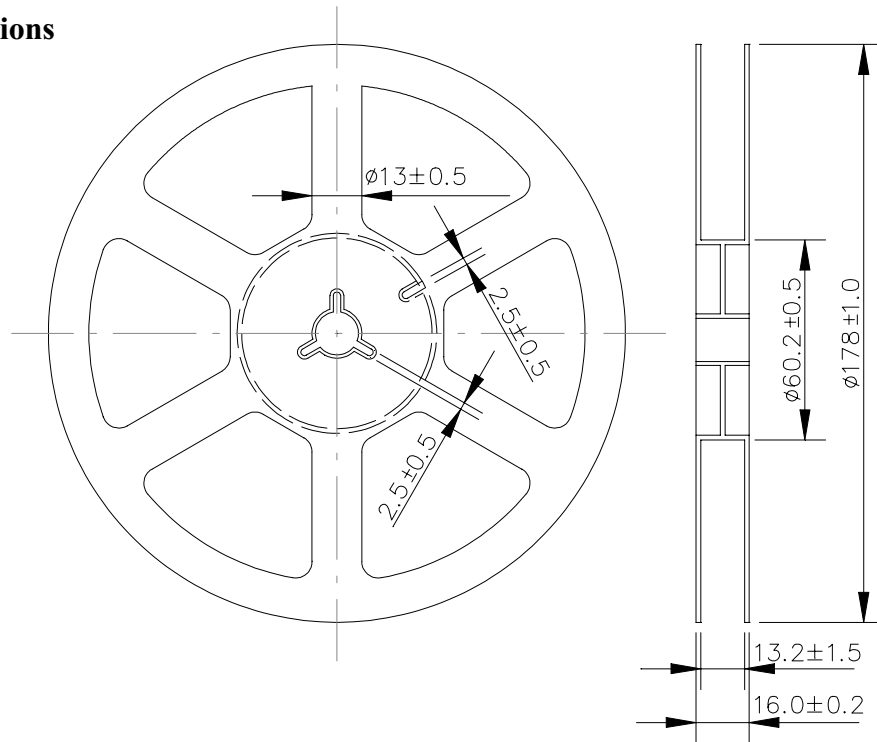

Fig.6 Response Time vs. Load Resistance



Package Dimensions



Loaded Quantity Per Reel 1000PCS/Reel

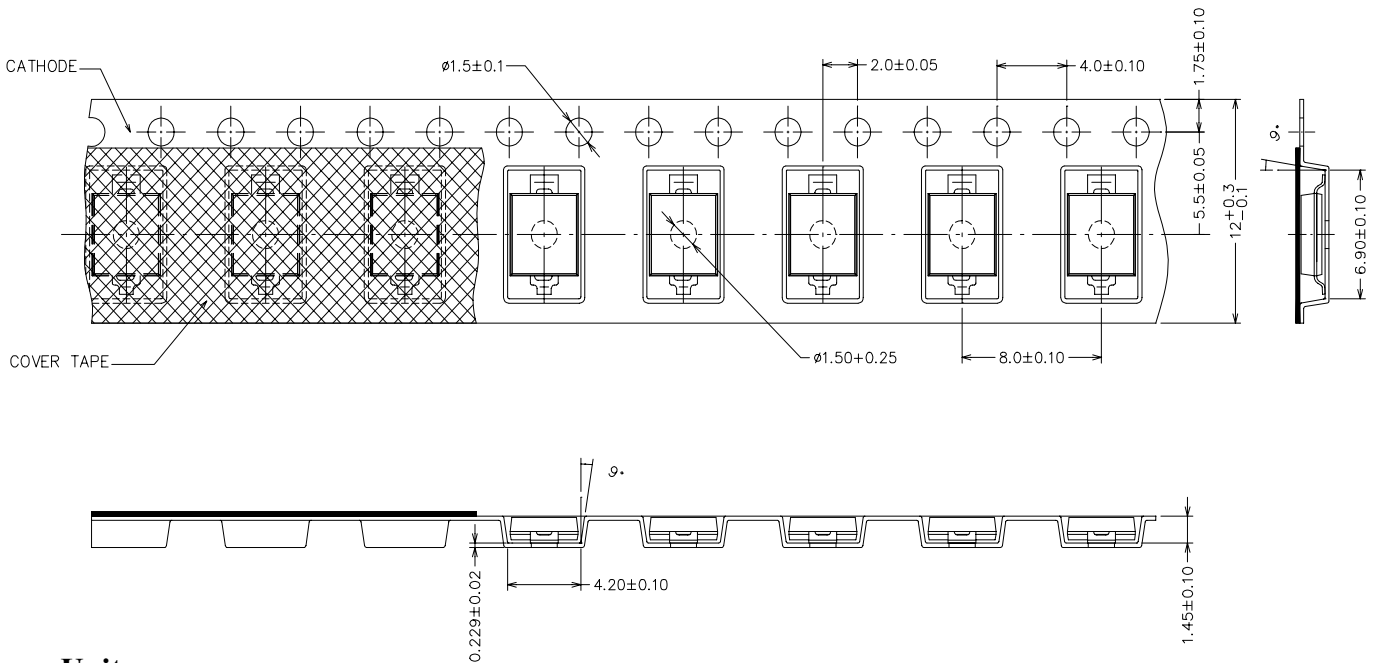

Unit :mm

Soldering heat

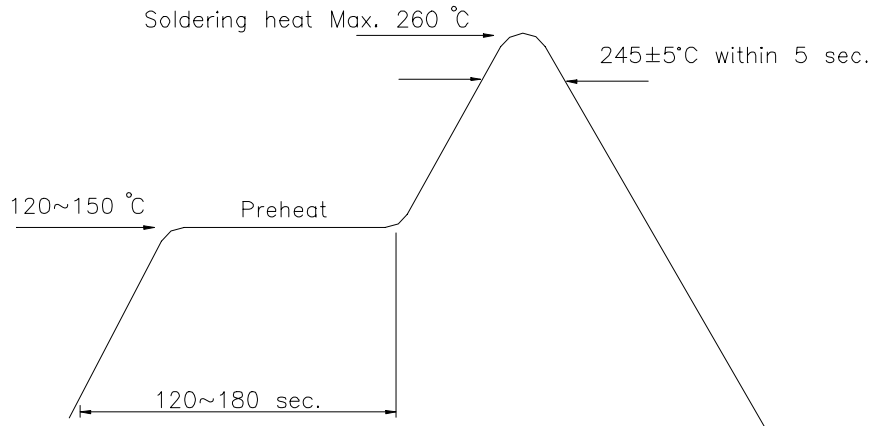

Soldering Iron

Basic spec is ≤ 5 sec when 260°C . If temperature is higher, time should be shorter ($+10^{\circ}\text{C} \longrightarrow -1\text{sec}$). Power dissipation of Iron should be smaller than 15W, and temperature should be controllable. Surface temperature of the device should be under 230°C .

Rework

1. Customer must finish rework within 5 sec under 245°C
2. The head of iron can not touch copper foil.
3. Twin-head type is preferred.

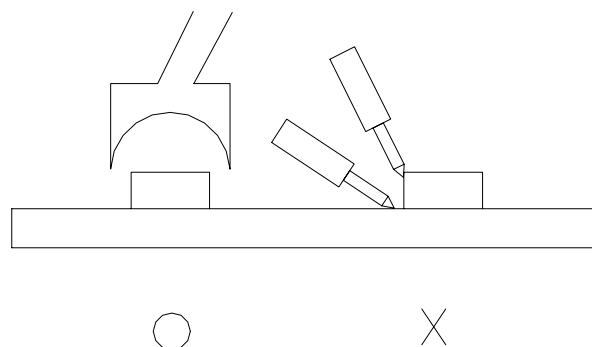

Reflow Temp./Time

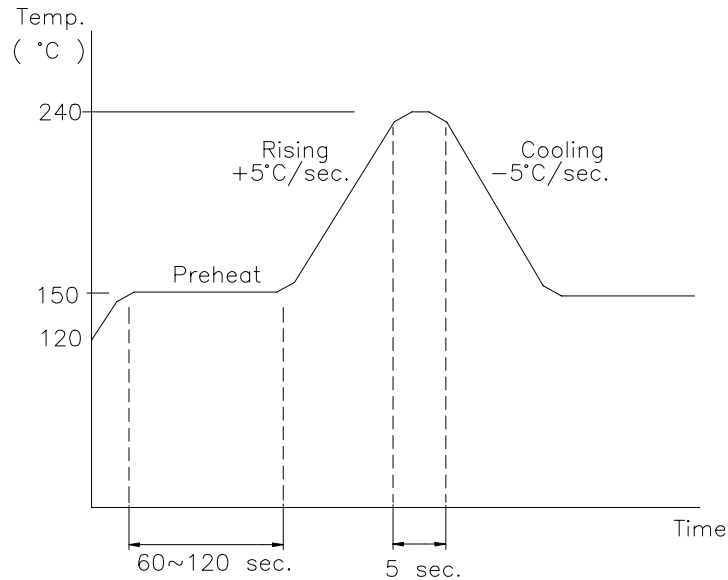

Precautions For Use

1. Over-current-proof

Customer must apply resistors for protection, otherwise slight voltage shift will cause big current change (Burn out will happen).

2. Storage

2.1 The operation of temperature and R.H are : 5°C ~ 35°C , R.H.60%.

2.2 Once the package is opened, the products be should be used within a week.

Otherwise, they should be keep in a damp proof box with desiccation anent.

Considering the tape life, we suggest our customers to use products within a year (from production date).

2-3. If opened more than one week in an atmosphere 5°C ~ 35°C, R.H.60%, they should be treated at 60°C ± 5°C for 15hrs.

2-4. When you discover that the desiccant in the package has a pink color (normal=blue), you should treat them in the same conditions as 2.3

Reliability Test Item And Condition

The reliability of products shall be satisfied with items listed below.

Confidence level : 90%

LTPD : 10%

NO.	Item	Test Conditions	Test Hours/ Cycles	Sample Sizes	Failure Judgement Criteria	Ac/Re
1	REFLOW	TEMP. : $240^{\circ}\text{C} \pm 5^{\circ}\text{C}$ 5secs	6Mins	22pcs	$I_L \leq L \times 0.8$ $V_F \geq U \times 1.2$ U : Upper Specification Limit L : Lower	0/1
2	Temperature Cycle	H : $+85^{\circ}\text{C}$ 30mins \updownarrow 5mins L : -55°C 30mins	50Cycles	22pcs		0/1
3	Thermal Shock	H : $+100^{\circ}\text{C}$ 5mins \updownarrow 10secs L : -10°C 5mins	50Cycles	22pcs		0/1
4	High Temperature Storage	TEMP. : $+100^{\circ}\text{C}$	1000hrs	22pcs		0/1
5	Low Temperature Storage	TEMP. : -55°C	1000hrs	22pcs		0/1
6	DC Operating Life	$V_R=5\text{V}$	1000hrs	22pcs		0/1
7	High Temperature/ High Humidity	$85^{\circ}\text{C} / 85\% \text{ R.H}$	1000hrs	22pcs		0/1

Packing Quantity Specification

1. 1000Pcs/1Volume , 1Volume/1Bag
2. 10Bag/1Carton

Label Form Specification

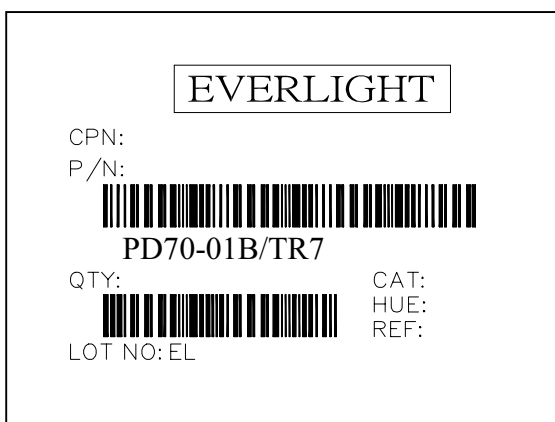

CPN: Customer's Production Number
P/N : Production Number
QTY: Packing Quantity
CAT: Ranks
HUE: Peak Wavelength
REF: Reference
LOT No: Lot Number
MADE IN TAIWAN: Production Place

Notes

1. Above specification may be changed without notice. EVERLIGHT will reserve authority on material change for above specification.
2. When using this product, please observe the absolute maximum ratings and the instructions for using outlined in these specification sheets. EVERLIGHT assumes no responsibility for any damage resulting from use of the product which does not comply with the absolute maximum ratings and the instructions included in these specification sheets.
3. These specification sheets include materials protected under copyright of EVERLIGHT corporation. Please don't reproduce or cause anyone to reproduce them without EVERLIGHT's consent.

EVERLIGHT ELECTRONICS CO., LTD.
Office: No 25, Lane 76, Sec 3, Chung Yang Rd,
Tucheng, Taipei 236, Taiwan, R.O.C

Tel: 886-2-2267-2000, 2267-9936
Fax: 886-2267-6244, 2267-6189, 2267-6306
<http://www.everlight.com>